



User Manual

EC335 4DC Environmental Condition Controller



Version 2

© 2018 BKT Elektronik

Table of contents

DEVICE DESCRIPTION	4
1 PACKAGING CONTENTS.....	4
2 TECHNICAL PARAMETERS	4
3 SOCKET VIEW AND DESCRIPTION.....	5
4 ADDITIONAL COMPONENTS.....	6
4.1 Analogue sensors.....	6
4.2 Digital sensors.....	7
4.3 Extension modules and accessories	7
5 QUICK START GUIDE.....	9
5.1 Installation	9
5.2 Connection.....	9
5.3 Restoring default settings.....	9
5.4 Initial configuration	10
5.5 User Logging out.....	11
6 CONFIGURATION.....	12
6.1 Horizontal menu	12
6.2 Vertical menu	12
6.3 Saving settings into non-volatile memory	13
6.4 General statistics	13
6.5 System tree (system components)	13
6.5.1 Adding a new group	14
6.5.2 Adding an email notification	14
6.5.3 Adding a trap notification	14
6.5.4 Adding an SMS notification.....	15
6.5.5 Adding a timer	15
6.5.6 Adding a trigger.....	15
6.5.7 Adding PING functions	16
6.5.8 Adding an SNMP Get.....	16
6.5.9 Adding a camera	16
6.6 Dry contacts (binary inputs for potential-free contacts)	17
6.7 Event log	17
6.8 Logical schemes	17
6.9 Cameras.....	18
6.10 Map.....	18
6.11 Users.....	18
6.12 CAN configuration (extension module)	19
6.13 Graphs	21
6.14 Reset smoke detectors	21
6.15 Preferences (system settings).....	22
6.15.1 Web interface settings.....	22
6.15.2 Network settings.....	22
6.15.3 Time settings.....	22
6.15.4 Logging settings	23
6.15.5 DynDNS settings.....	23
6.15.6 SNMP settings.....	23
6.15.7 RADIUS settings.....	24

6.15.8	FTP backup settings	24
6.16	System menu (system management)	25
6.16.1	Restoring default settings through a website	25
6.16.2	Restarting the device	25
6.16.3	Firmware update.....	26
6.16.4	Export data to a file.....	27
6.16.5	Restoring settings from a file	27
7	DOCUMENT REVISIONS.....	27

Warning:

This is a Class A product. In a domestic environment this product may cause radio interference in which case the user may be required to take adequate measures.

1 DEVICE DESCRIPTION

The EC335 4DC controller is designed to monitor environmental parameters (temperature, humidity, etc.) in a telecommunications cabinet or small rooms. Its purpose is to warn users about possible emergency situations and report any failures. The following can be connected to the controller: up to 4 analogue sensors, 4 sensors with potential-free contacts and two signalling devices. With extension modules can be connected up to 28 analogue sensors, 36 sensors with potential-free contacts, up to 20 1-wire sensors. To keep a satisfactory system performance, it is not recommended to connect more than 40 sensors to the controller.



2 PACKAGING CONTENTS

The packaging of the EC335 controller includes:

1. EC335 4DC controller
2. 230V AC, 12V DC 1A plug adapter
3. 1U 19" bracket
4. RJ45-RJ45 patchcord
5. Cable: mini-B USB plug – A USB socket
6. 6-pin and 3-pin terminal connector

3 TECHNICAL PARAMETERS

Hardware	
Analogue inputs	4 inputs (RJ12 sockets) for compatible analogue sensors. Any combination of 4 sensors can be connected to the device. Some sensors can be connected in stacks. The type of a sensor is detected automatically.
Inputs for potential-free contacts	4 inputs (removable 6-pin terminal strip) for any sensors with potential-free contacts
Outputs	2x 12V/250mA voltage outputs (removable 3-pin terminal strip)
CAN connector	Connector (RJ12 socket) for up to 8 extension modules for additional analogue EE321 inputs and additional EE322 inputs for potential-free contacts
Other connectors	10/100Mbps (RJ45 socket) Ethernet port, USB 2.0 port (Mini-B socket)
Other	Optional card of a GSM module.
Power supply	External 12V/1A plug adapter, power consumption $\leq 10W$
Dimensions	180x80x33 (width x depth x height)
Operating conditions	Temperature: 0°C - 60°C, Humidity: 0% - 90% RH (no condensation)
Storage conditions	Temperature: -25°C - 85°C, Humidity: 0% - 95% RH (no condensation)
Weight	700g
Index	122EC003351
Software	
Operating system	Linux
Configuration	Through a web interface
Supported protocols	HTTP, HTTPS, PING, DHCP, RADIUS, SYSLOG, FTP, SNTP, SMTP, SNMP (v1,v2,v3)
Alarm notification	E-mail, SNMP trap, internet SMS gateway, SMS (optionally with GSM modem)

4 SOCKET VIEW AND DESCRIPTION

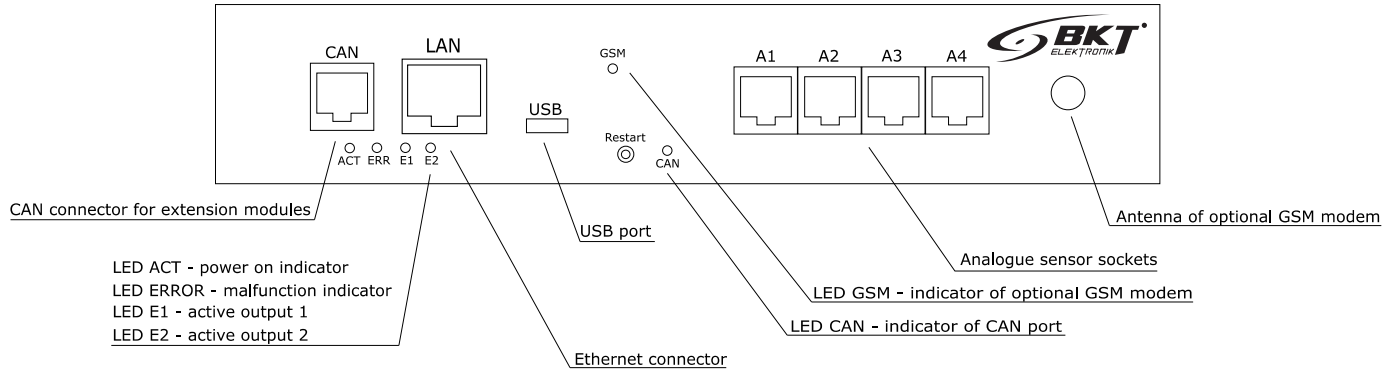

Fig 1. Front view

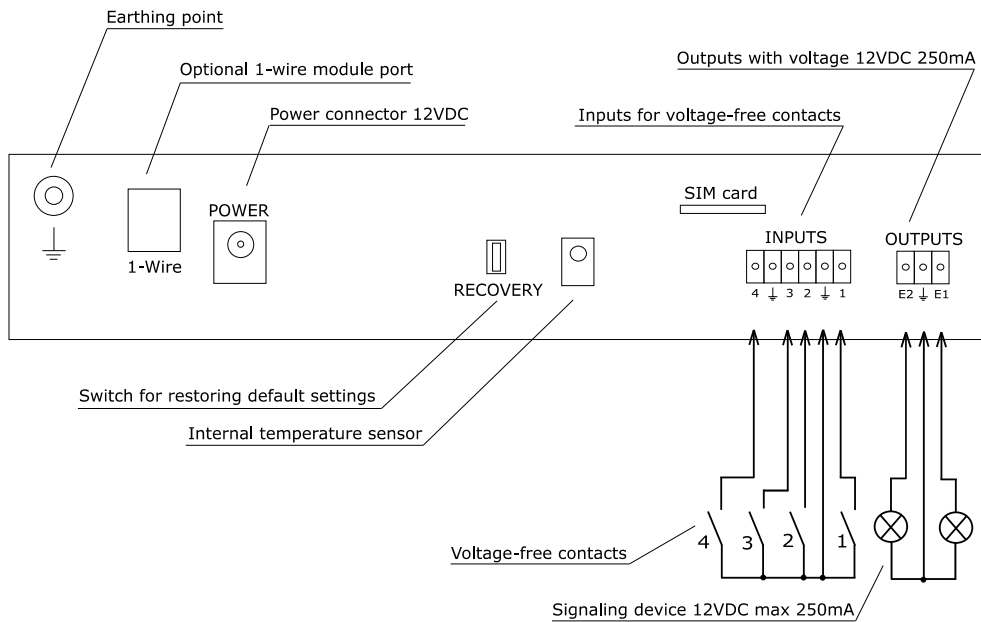



Fig 2. Rear view



5 ADDITIONAL COMPONENTS

5.1 Analogue sensors



Type	Description	Index
	ES350 – Temperature sensor Measurement range: -10°C - +100°C Dimensions: 60x18x18 Maximum length of a connection cable: 100m	122ES003500
	ES351 – Humidity sensor Measurement range: 10% - 95% RH Dimensions: 60x18x18 Maximum length of a connection cable: 50m	122ES003510
	ES352 – 230V AC voltage sensor Measurement range: 90VAC - 250VAC Dimensions: 63x66x30 Maximum length of a connection cable: 100m	122ES003520
	ES353 – Door sensor (reed relay + magnet) Stack connection of up to 10 sensors Dimensions: 60x18x18 Maximum length of a connection cable: 150m	122ES003530
	ES354 – Vibration sensor Stack connection of up to 10 sensors Dimensions: 60x18x18 Maximum length of a connection cable: 150m	122ES003540
	ES356 – Optical smoke sensor Stack connection of up to 10 sensors Dimensions: ϕ 100x45 Maximum length of a connection cable: 150m	122ES003560
	ES357 – Passive infrared sensor Movement detection range: 100° x 12m Dimensions: 105x57x40 Maximum length of a connection cable: 50m	122ES003570
	ES358 – External temperature sensor Measurement range: -40°C - +100°C Dimensions: ϕ 7x30 + 15 m cable Maximum length of a connection cable: 100m	122ES003580
	ES359 – Flood sensor Detection delay: 1s Dimensions: 60x18x18 Maximum length of a connection cable: 100m	122ES003590
	ES360 – Flood sensor for a water detection cable For connection of an ES361 water detection cable Dimensions: 60x18x18 Maximum length of a connection cable: 100m	122ES003600
	ES361 – Sensor detecting water and other conductive liquids An ES360 sensor is required for connection Dimensions: 60x18x18 Available lengths: 6m, 10m, 17m, 25m, 50m	122ES003610



	<p>ES362 - 4-20mA sensor Any sensors with 4-20mA output can be connected to the controller. Galvanic insulation 1kV between the input and the output. Dimensions: 60x18x18</p>	122ES003620
	<p>ES363 - 60V DC voltage sensor Galvanic insulation 1kV between the input and the output. Measurement range: 0VDC - 60VDC Dimensions: 60x18x18</p>	122ES003630

5.2 Digital sensors

Type	Description	Index
	<p>ES340 - Integrated smoke, humidity 10-95%, temperature - 10...+85°C sensors; CAN bus Possibility to connect up to 8 devices in a daisy chain (sensor has 2 CAN ports) Dimensions: ϕ100x45 Maximum cable length: 200m</p>	122ES003400
	<p>ES365 - 1-wire temperature sensor Measurement range: -50...+105°C Possibility to connect up to 20 sensors in a daisy chain Dimensions: 60x18x18 Maximum cable length: 100m</p>	122ES003650
	<p>ES366 - Outdoor 1-wire temperature sensor Measurement range: -50...+105°C Dimensions: ϕ7x30 + 15m cable Maximum cable length: 100m</p>	122ES003660

5.3 Extension modules and accessories

Type	Description	Index
	<p>EE321 – Extension module with additional 8 analogue inputs. The module is connected to a CAN controller connector. The controller supports up to 28 analogue sensors. The module has no 19" brackets. Dimensions: 110x68x40</p>	122EE003210
	<p>EE322 – Extension module with additional 32 inputs for potential-free contacts. The module is connected to a CAN controller connector. The controller supports up to 32 inputs of potential-free contacts. 19" brackets included. Dimensions: 215x40x40</p>	122EE003220
	<p>EE323 – 1-wire extension module The module is mounted inside the controller. Dimensions: 44x23x15 The module is supplied with a connection cable.</p>	122EE003230

	<p>EA311 - 1U bracket for a 19" cabinet for EC335 4DC Dimensions: 482x44x80</p>	<p>122EA003110</p>
	<p>EA317 - GSM modem for EC300 4DC Dimensions: 60x50x15 A modem for SMS communication operating in GSM 850/900/1800/1900 MHz networks.</p>	<p>122EA003170</p>

6 QUICK START GUIDE

6.1 Installation

The device can be installed on the wall using provided openings in the housing or mount it to a 19" profile with additional brackets. The 19" bracket symbol is shown in the 'Accessories' section.

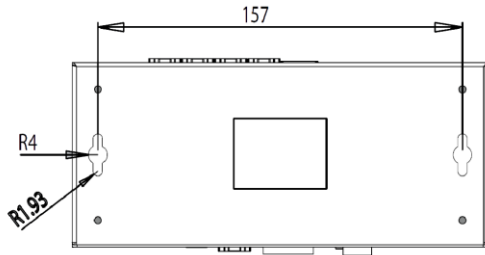

6.2 Connection

1. Connect the analogue sensors to any A1-A4 socket.
2. Connect the RJ45-RJ45 patchcord to the LAN socket and the other end to the computer.
3. Connect the power adapter to the POWER socket.

6.3 Restoring default settings

In order to make sure that all settings have default values, it is recommended to reset the default setting before the first start-up.

NOTE: All current settings will be deleted.



1. Make sure that the Normal/Recovery is in the NORMAL position.
2. Connect the module power supply.
3. Wait for ACT LED flashing.
4. Switch the Normal/Recovery button to the RECOVERY position and wait until the LED ERROR indicator starts to flash (approx. 10 second).
5. When the LED ERROR indicator is still on, restore the button to the NORMAL position and wait until the device restarts.
6. The default settings have been restored.

Default settings	
IP address	192.168.0.193
Network mask	255.255.255.0
Network gate	192.168.0.1
DNS	192.168.0.1
DHCP client	Disabled
Passwords	User: guest; password: guest

6.4 Initial configuration

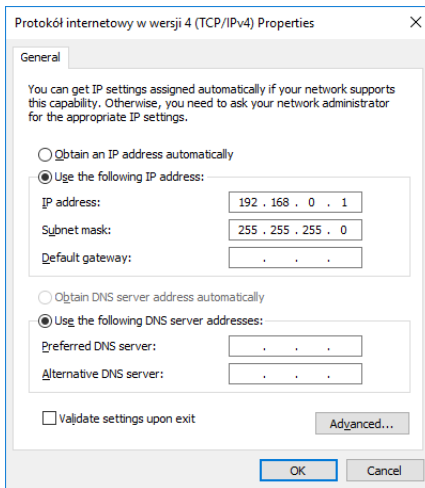

Configure the computer network card for operation in the same network as EC335. For example, you can use settings as shown in the figure.

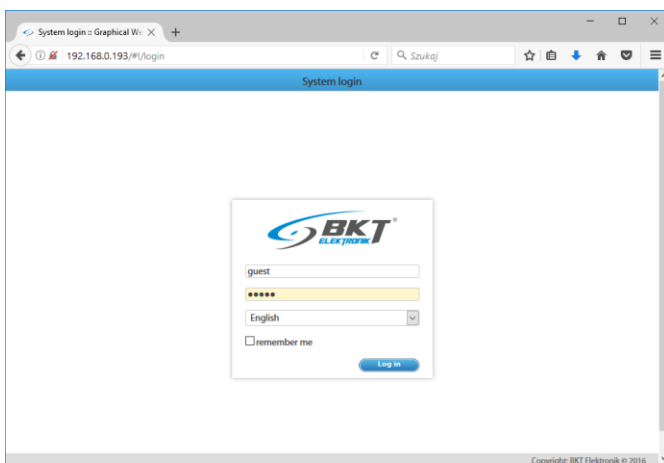

Run the browser and enter <http://192.168.0.193> in the address bar. Enter the following in the login window: user: guest, password: guest.

Use the displayed wizard for initial configuration.

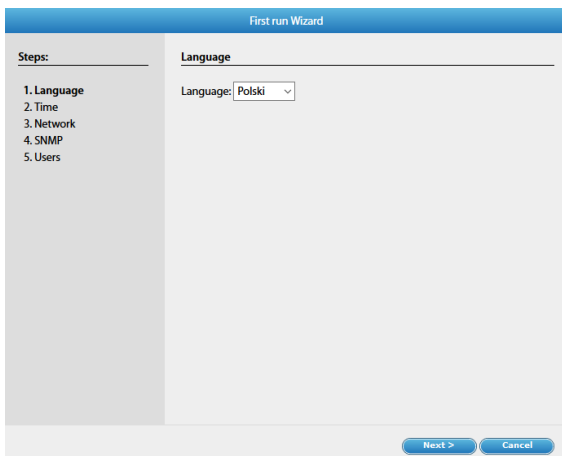

Choose the interface language.

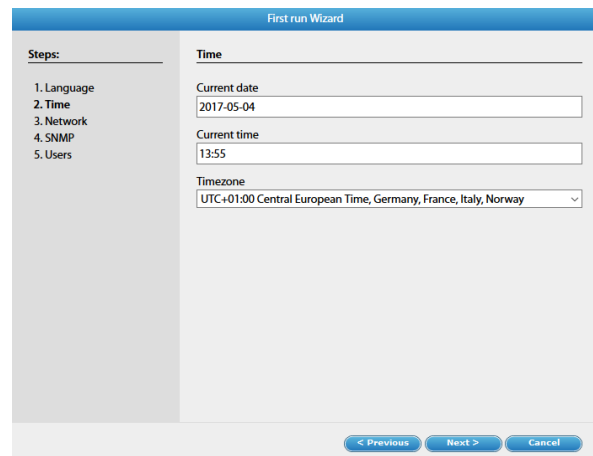

Set the date and time.

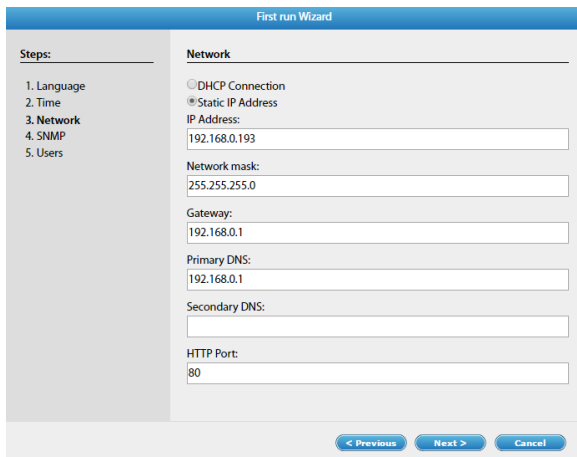

If necessary, change the network settings.

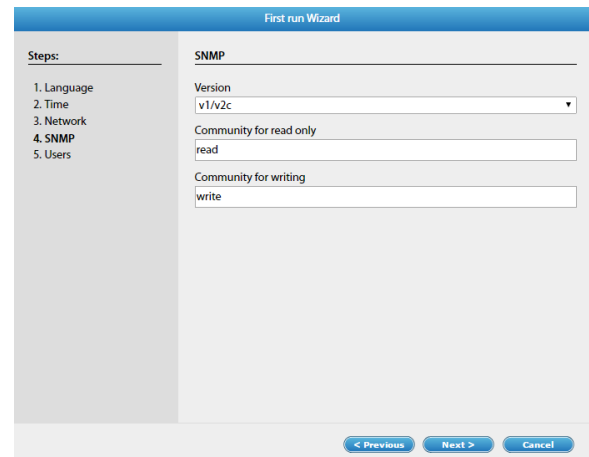

If necessary, change the SNMP protocol communication settings.

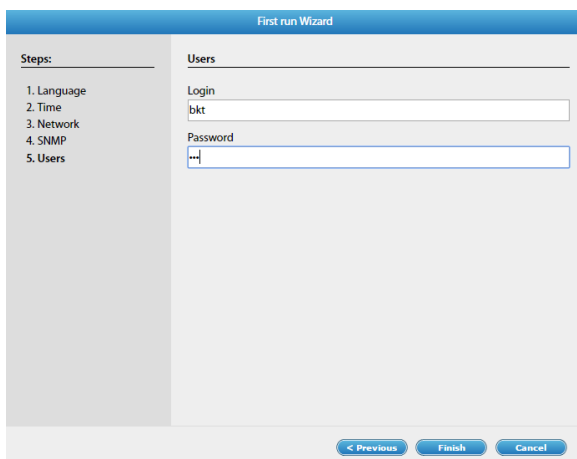

Create a new user. Click *Finish* and wait until the configuration is saved.

6.5 User Logging out

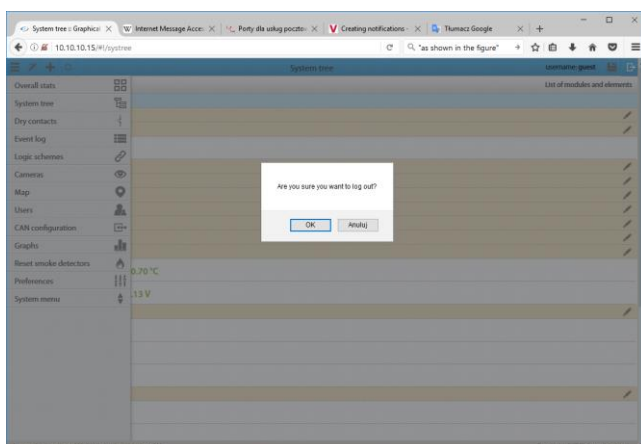









You can log out when you click on the *Logout* button from horizontal menu.













7 CONFIGURATION

7.1 Horizontal menu



-  Show and hide the vertical menu.
-  Run the initial configuration wizard.
-  Add a new element. This function is available only on certain screens selected from the vertical menu.
-  Refresh the view.
-  Additional settings. This function is available only on certain screens selected from the vertical menu.
-  Reset the smoke sensors. This function is available only after selecting 'Reset the smoke sensors' from the vertical menu.
-  Write the configuration to non-volatile memory of the module. Any configuration changes must be written to non-volatile memory, if they need to be kept after resetting the device.
-  Log out.

7.2 Vertical menu

Overall stats		General view of the system status.
System tree		View of all system components, incl. sensor values.
Dry contacts		View of the potential-free contact status.
Event log		View of the system event history.
Logic schemes		Creating relations between the sensors and potential alarms.
Cameras		Camera image preview.
Map		View of sensor parameters against the room layout.
Users		User management.
CAN configuration		Configuration of extension modules.
Graphs		Displaying sensor values on charts.
Reset smoke detectors		Resetting the smoke sensors following an alarm.
Preferences		System settings.
System menu		Firmware update and data export.

7.3 Saving settings into non-volatile memory



All new setting must be saved into FLASH non-volatile memory. Otherwise they will only be valid until the next reboot.

7.4 General statistics

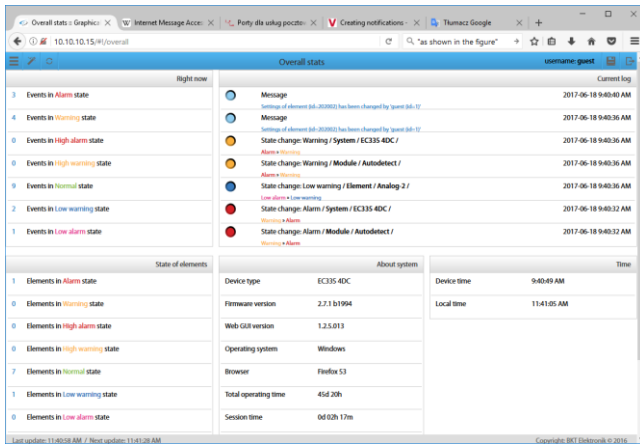

Select *Overall Stats* from the vertical menu to display basic data on the system status.

7.5 System tree (system components)

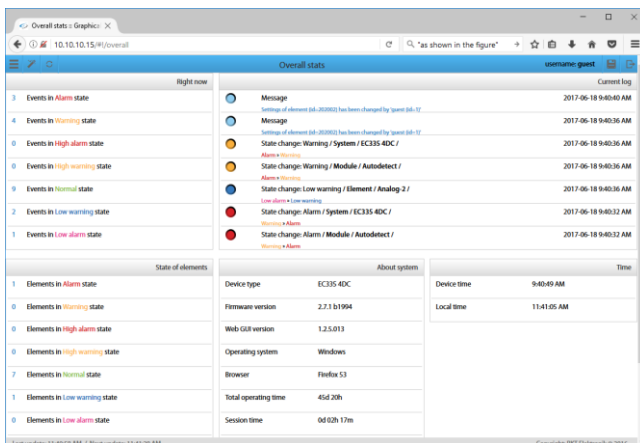

Select *System tree* from the vertical menu to display all system components. On this page, you can add, remove and modify settings of individual components.

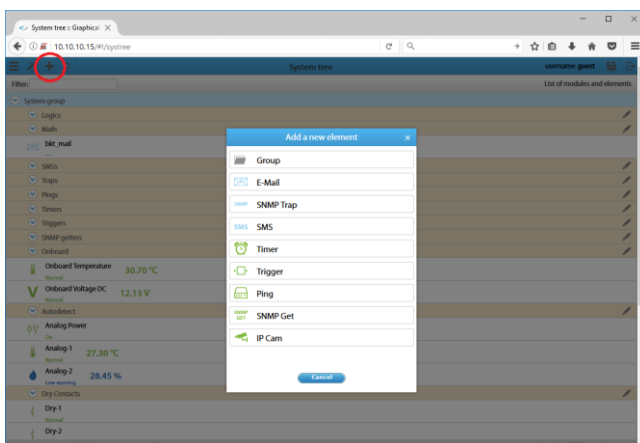

In order to add a new component, click the '+' button in the horizontal menu.

To maintain proper performance of the device, it is recommended to use max 100 components in the system.

To maintain the settings after restarting the controller, write them to non-volatile memory.

7.5.1 Adding a new group

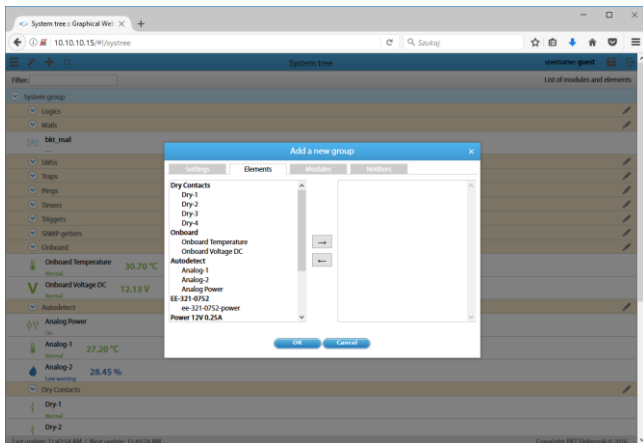

By default, there is one group in the system. Additional groups divide the system into parts, which in turn allows the user to assign individual components to proper groups. The user can be granted rights to manage a specific group.

7.5.2 Adding an email notification

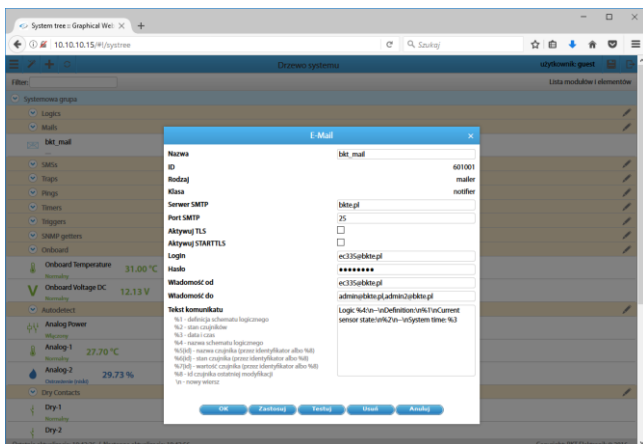

The system allows the user to configure email accounts which shall be used to notify of alarm situations. Only the SMTP service can be used.

7.5.3 Adding a trap notification

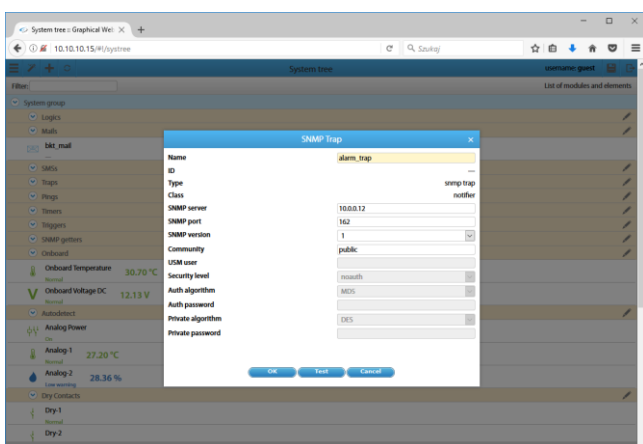

A trap is an alarm notification used in the SNMP protocol. Such notification can be sent to a network monitoring system.

7.5.4 Adding an SMS notification

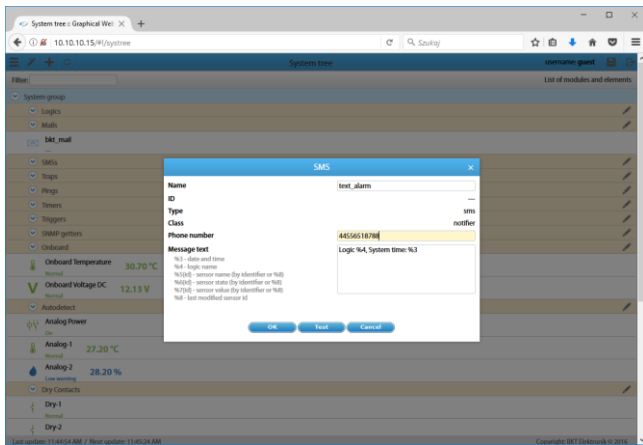

If there is an optional GSM modem installed in the controller, it is possible to send SMS (text message) notifications.

SMS notifications can also be sent via an SMS Internet gateway. The GSM modem is not required then.

7.5.5 Adding a timer

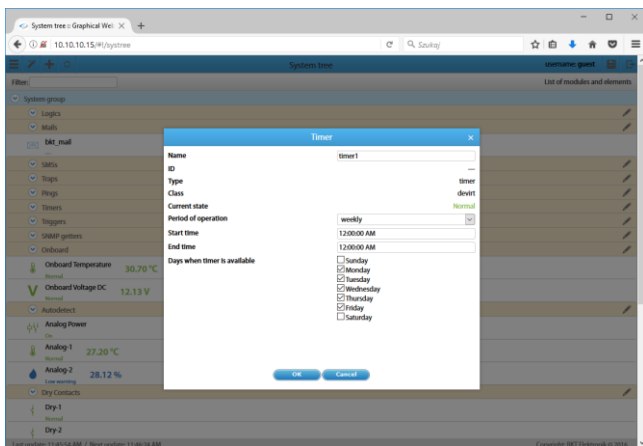

Time conditions can be introduced to the system. For this purpose, timers are used. They can be in an active or normal state in defined hours. In logical schemes they can be used as instruction execution conditions.

7.5.6 Adding a trigger

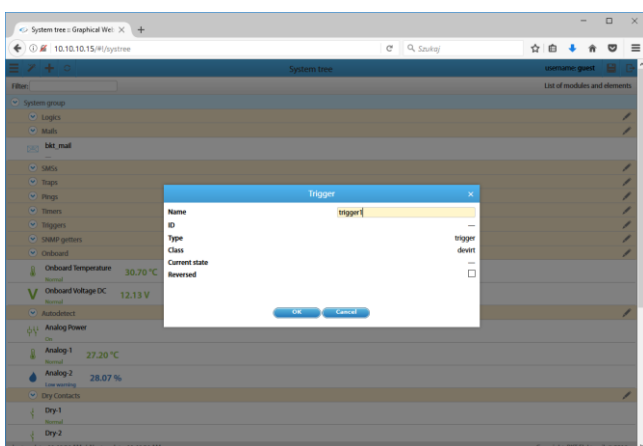

Triggers perform a similar function as a flag, however they can also generate an event. They can be used to define logical schemes.

7.5.7 Adding PING functions

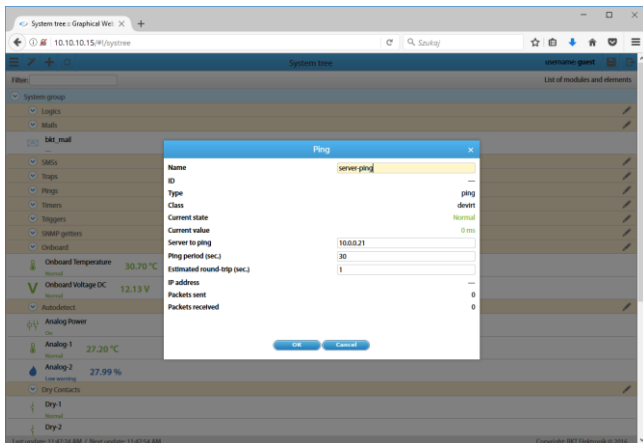

The controller can monitor an external device by sending a PING on a regular basis. In logical schemes, it is possible to define, e.g. sending an email alarm when the external device stops to respond to the PING.

7.5.8 Adding an SNMP Get

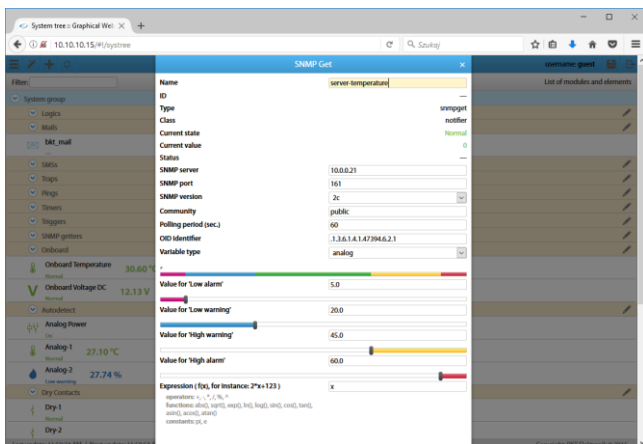

The controller can ask the external device for its parameters using the SNMP v1 and v2. Values of this parameters deviating from the defined ones can generate an event.

7.5.9 Adding a camera

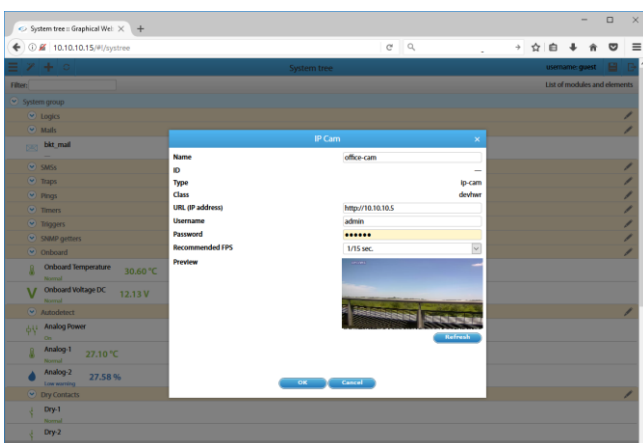

The controller automatically detects a UVC (USB Video Class) type camera connected to a USB port, which supports MPEG compression. It is recommended to use C210, C270, C310 and C510 Logitech cameras.

The controller can also be used to configure some IP cameras.

7.6 Dry contacts (binary inputs for potential-free contacts)

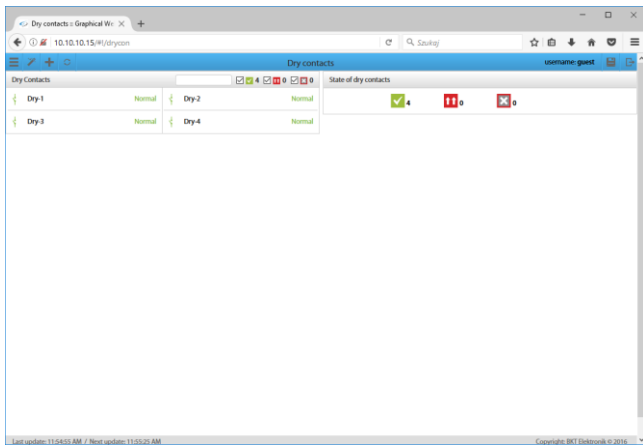

Select *Dry contacts* from the vertical menu to view the state of binary inputs for potential-free contacts.

7.7 Event log

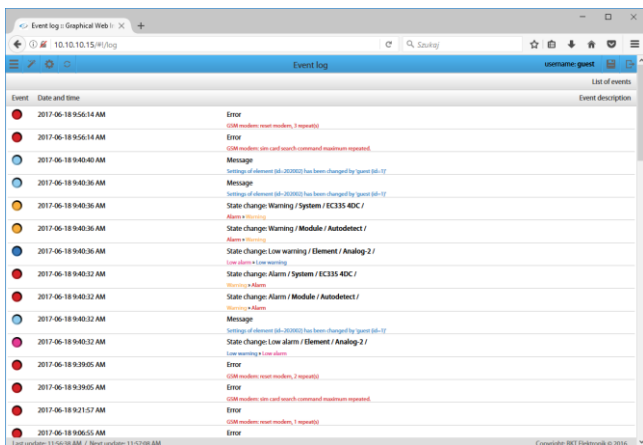

Select *Event log* from the vertical menu to display logs on all system events.

7.8 Logical schemes

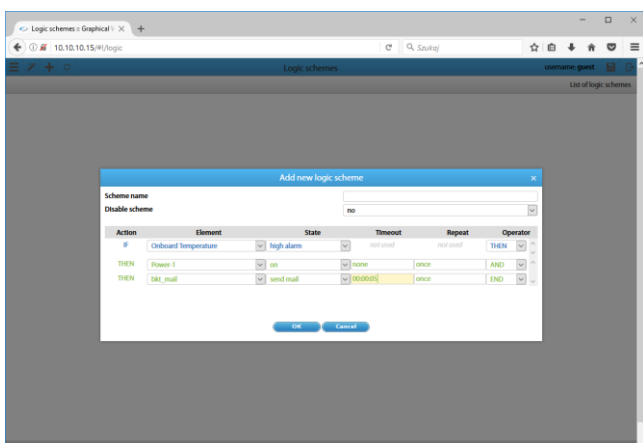

Select *Logical schemes* from the vertical menu to create relations between the system components (sensors, controller inputs, outputs, etc.). In order to add a new logical relation, click the '+' button in the horizontal menu. 'IF THEN' and 'AND' and 'OR' logical functions are used. The *Timeout* function means an instruction execution delay.

To maintain the settings after restarting the controller, write them to non-volatile memory.

7.9 Cameras

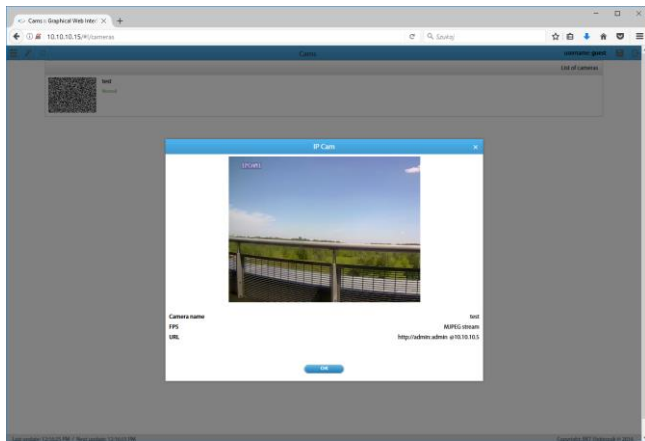

Select *Cameras* from the vertical menu to view the image captured from installed cameras. Select *System tree* to configure the cameras.

7.10 Map



The system provides a function of displaying the state of sensors against the building layout. Select *Map* from the vertical menu. Click *Settings* in the horizontal menu to configure this page.

To maintain the settings after restarting the controller, write them to non-volatile memory.

7.11 Users

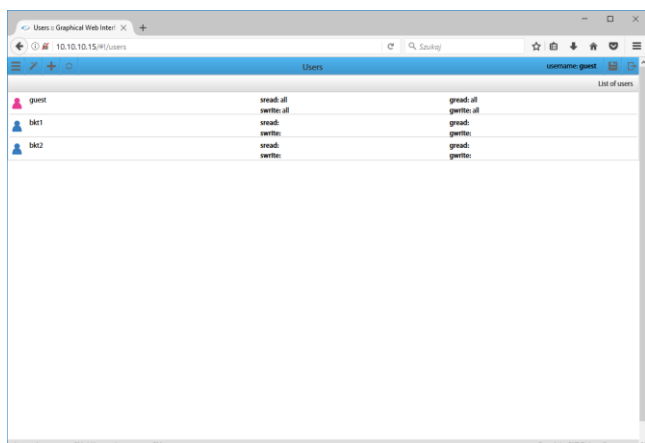

Select *Users* from the vertical menu to manage system users, create new users, remove users and grant rights.

Click the '+' button in the horizontal menu to add a new user.

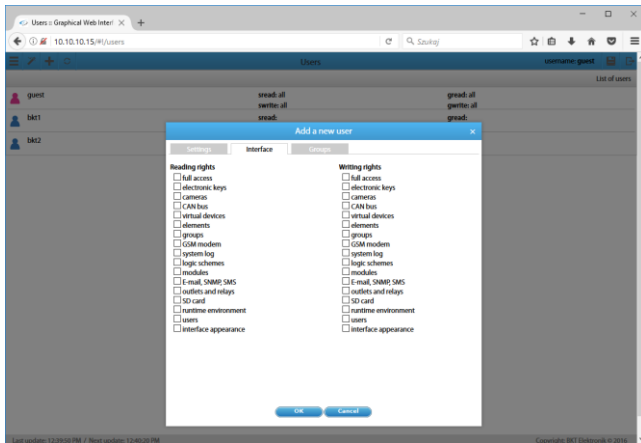

Enter the user name and password in the pop-up window and grant it appropriate right.

To maintain the settings after restarting the controller, write them to non-volatile memory.

7.12 CAN configuration (extension module)

Devices extending the number of analogue ports - EE321 and binary input ports for potential-free contacts - EE322 can be connected to the controller. One controller can support up to 3 EE321 devices and one EE322 device.

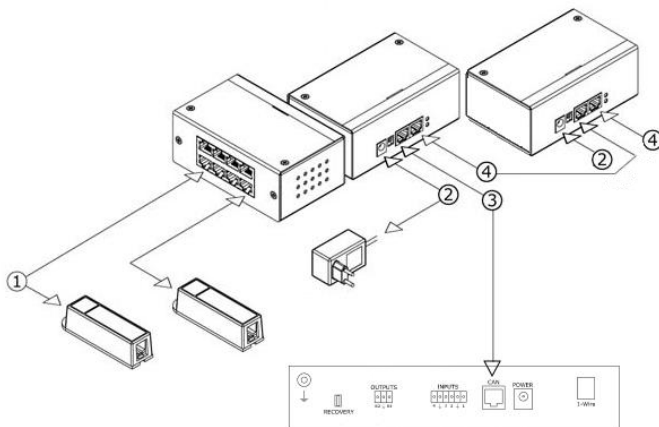

Connect CAN devices to the controller with a 6-wire cable ended with RJ12 plugs. The devices should be connected in stacks (from one device to another). The CAN socket number is irrelevant, either CAN1 or CAN2 can be used. The maximum CAN bus length is 300 m.

1. Connection of sensors to a device extending the number of analogue inputs.
2. Connection of 12VDC/1A power supply.
3. Connection of a CAN bus to the EC335 controller.
4. Stack connection of the CAN bus (from one device to another).

The bus terminator in the last device (from the controller) must be enabled. The bus terminator in the remaining devices must be disabled. The TR switch (activating the terminator) in ON and OFF position is shown in the drawing on the left.

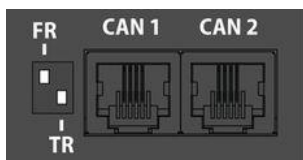

FR-off, TR-on

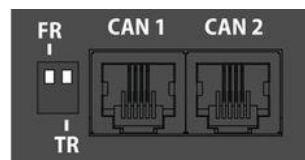

FR-off, TR-on

The FR switch is for servicing and must be in OFF position during normal operation.

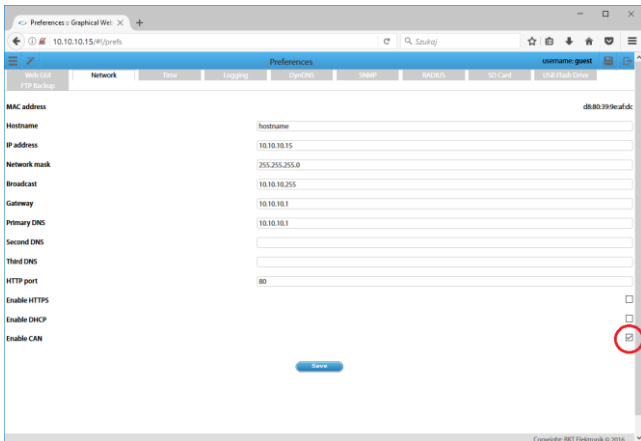

Activate the CAN bus. Select Preferences→*Network* from the vertical menu. Check the *Enable CAN* box and click *Save*.

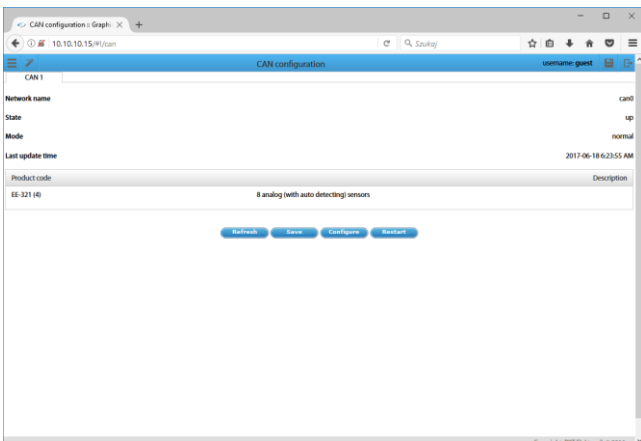

Select *CAN configuration* from the vertical menu, then click the *Configure* button and wait approx. 2 minutes until the CAN bus is scanned and the device is configured. When the device appears on the list, click the *Save* button.

Refresh – refresh the list of devices on the bus and their status.

Save – write CAN settings to non-volatile memory.

Configure – search for extension modules on the bus.

Restart – restart the CAN bus.

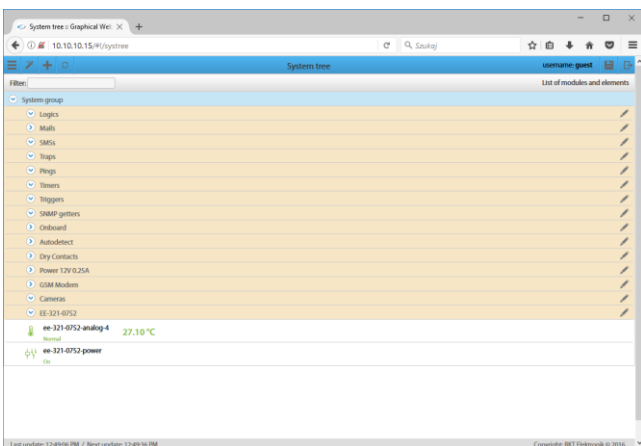

Following configuration, the extension module and sensors connected to it will be automatically detected and displayed in the system tree. Select *System tree* from the vertical menu.



The operating status of the CAN bus is signalled on the controller with the CAN indicator light.

CAN is off – the CAN bus has not been activated in the configuration.

CAN flashes – the CAN bus is active, but there is no communication with the extension module.

CAN is on – the CAN bus is active and there is communication with the extension module.

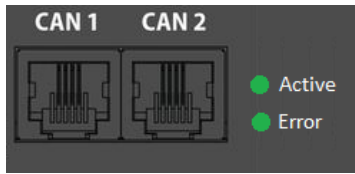

The extension modules have two indicator lights to signal the operating status.

Error is on, Active flashed – no communication with the controller.

Error is on, Active is off – there is communication with the controller, but the module is not configured in the controller.

Error is off, Active is on – the module works properly.

Error is off, Active is off – no power supply or damaged module.

7.13 Graphs

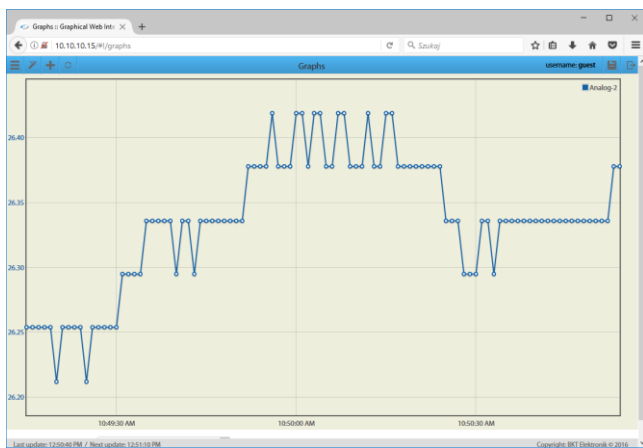

It is possible to display changes of values from the sensors on a chart. Select *Graphs* from the vertical menu.

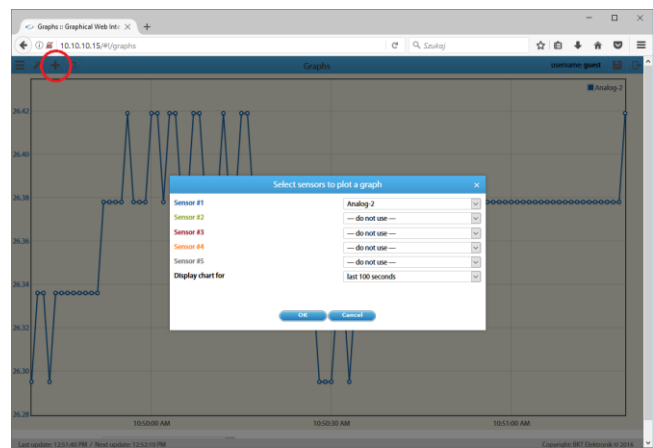

To add the sensor to a chart, use the '+' button from the horizontal menu.

7.14 Reset smoke detectors

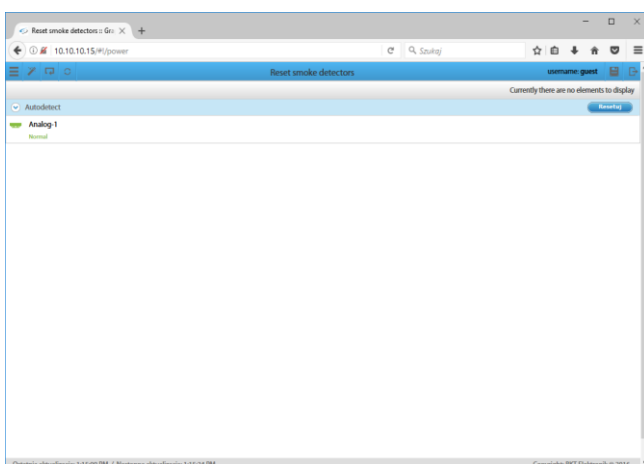

Once triggered (smoke detection), the sensors require a manual restart. This can be done through the controller web interface. Select *Reset smoke detectors* from the vertical menu. Resetting involves disconnecting the power supply from the sensors for a few seconds. All analogue sensors connected to the device where smoke is will be disconnected from the power supply for a moment.

7.15 Preferences (system settings)

7.15.1 Web interface settings

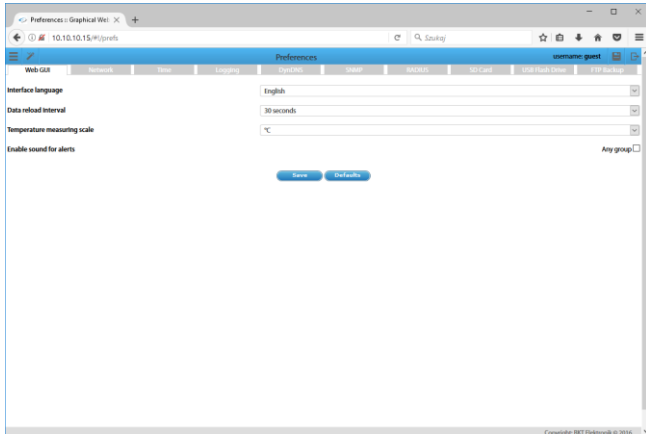

Select *Preferences*→*Web GUI* from the vertical menu.

Set the following web interface parameters:

- language
- automatic refresh rate
- temperature unit (Celsius or Fahrenheit degrees)
- activate an acoustic signal via the website when the alarms are active

7.15.2 Network settings

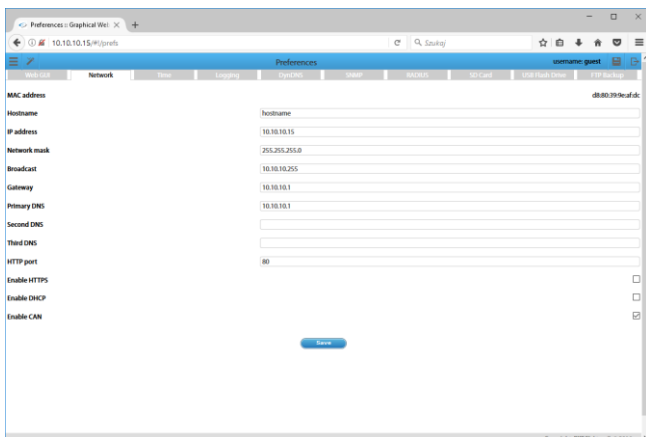

Select *Preferences*→*Network* from the vertical menu.

- IP address, subnetwork mask, broadcast, gate, DNS – to enter static network settings.
- HTTP port – it determines an access port to the device via a browser (default: 80).
- Enable HTTPS – activate encrypted connection via a browser.
- Enable DHCP – activate automatic import of network settings from a DHCP server.
- Enable CAN – this function must be checked if extension modules are to be used in the system.

7.15.3 Time settings

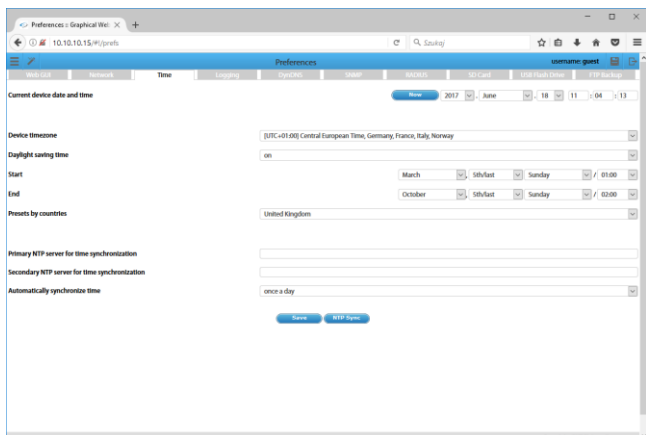

It is possible to set the device clock time manually and to set cyclical synchronisation with NTP servers. Select *Preferences*→*Time* from the vertical menu.

7.15.4 Logging settings

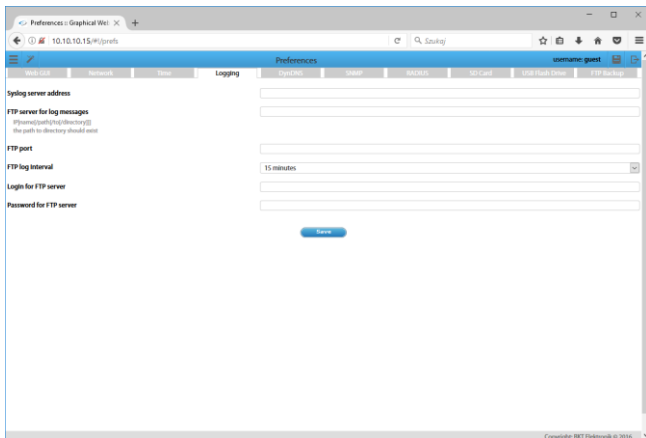

Readings of sensor and system log values can be saved to a file on an USB flash drive, FTP server, Syslog server (system logs only) or periodically sent to mail receiptment. Select *Preferences*→*Logging* from the vertical menu.

7.15.5 DynDNS settings

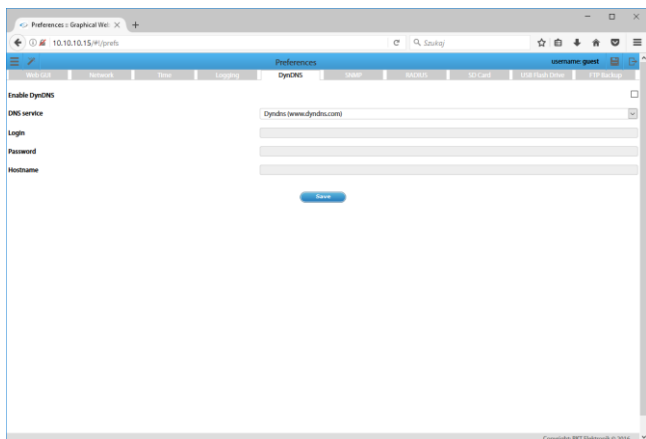

The DynDNS (www.dynDNS.com) or no-IP (www.no-ip.org) services can be used with the device. Select *Preferences*→*DynDNS* from the vertical menu.

7.15.6 SNMP settings

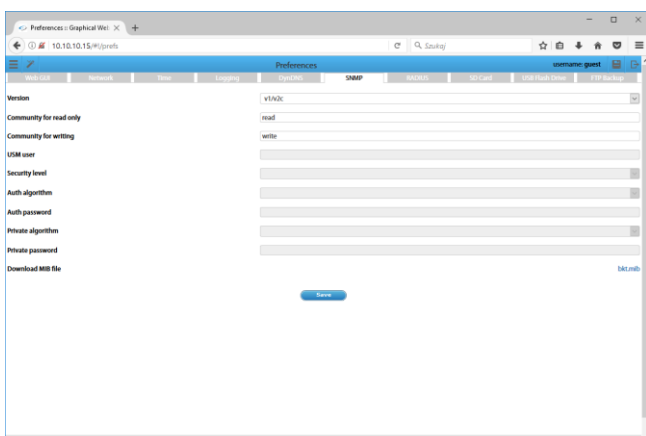

The device supports the SNMP (Simple Network Management Protocol) in versions 1, 2 and 3. In this tab, a Management Information Base with communication data can be downloaded. Select *Właściwości*→*SNMP* Preferences→*SNMP*) from the vertical menu.

7.15.7 RADIUS settings

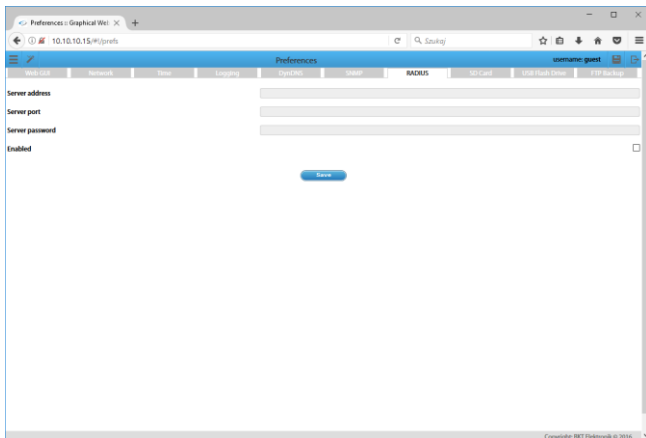

The device supports the RADIUS (Remote Authentication Dial-In User Service) protocol. Select *Preferences*→*RADIUS* from the vertical menu.

7.15.8 FTP backup settings

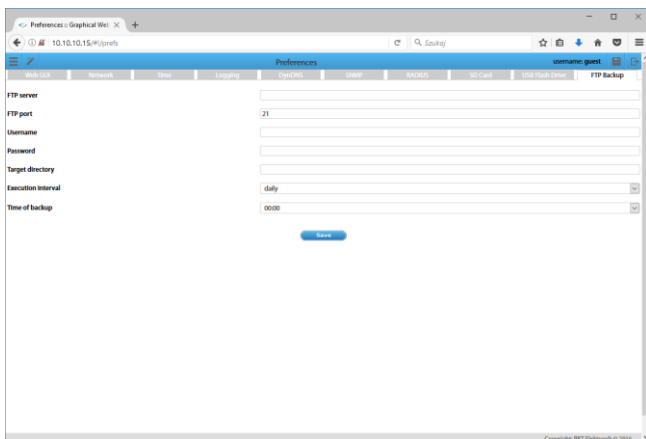

Device settings can be saved to a file on an FTP server on a regular basis. Select *Preferences*→*FTP Backup* from the vertical menu.

7.16 System menu (system management)

7.16.1 Restoring default settings through a website

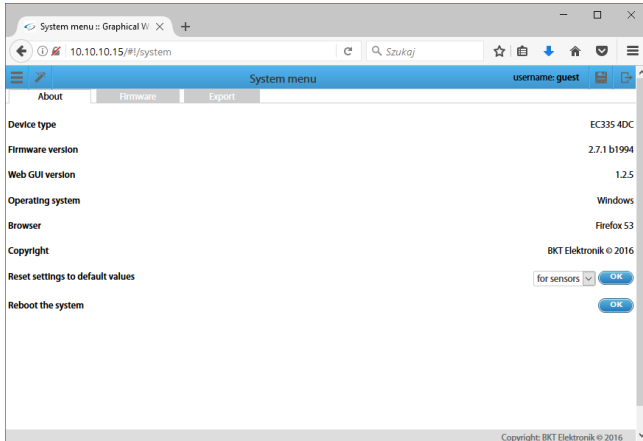

Select *System menu*→*About* from the vertical menu and click *OK* next to *Reset settings to default values*.

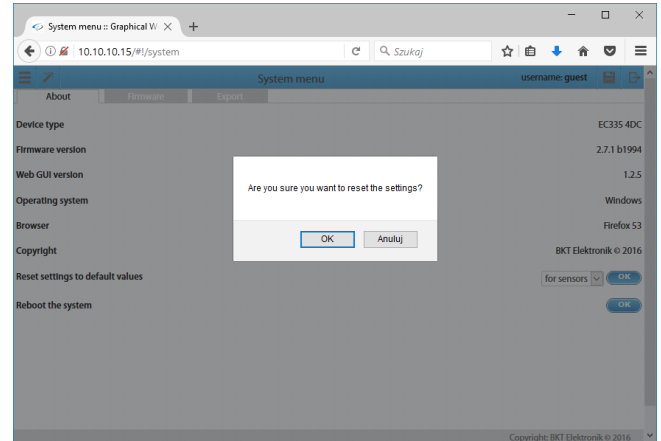

Confirm to reset default values and wait until the process is completed.

7.16.2 Restarting the device

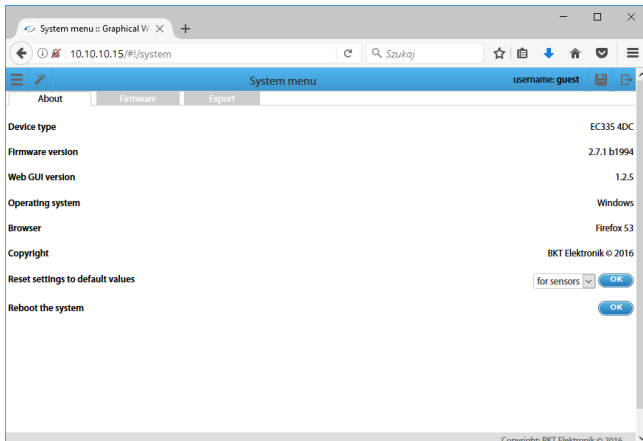

Select *System menu*→*About* from the vertical menu and click *OK* next to *Reboot the system*.

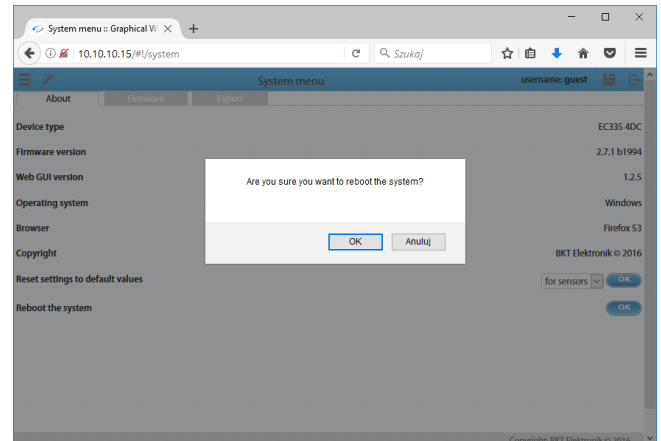

Confirm to restart the device and wait until the restarting process is completed.

7.16.3 Firmware update

A file with a firmware update is available on <http://www.bkte.pl>.

Note: It may become necessary to reconfigure the device after updating the firmware. It is recommended to reconfigure the device after resetting the default settings.

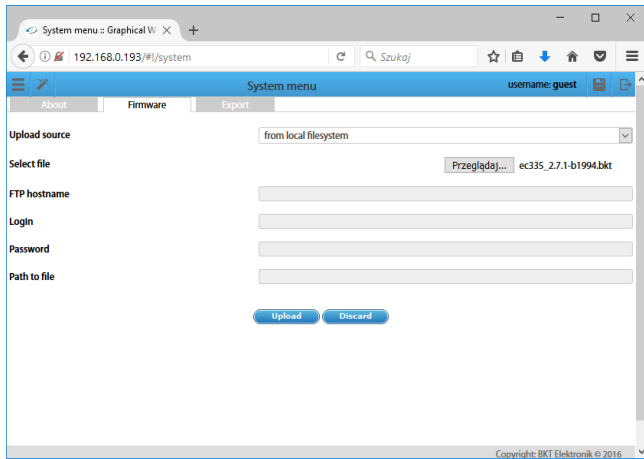

Select *System menu* → *Firmware* from the vertical menu, click *Browse* and choose a firmware update file, e.g. *ec335_2.7.3-b012.bkt*.

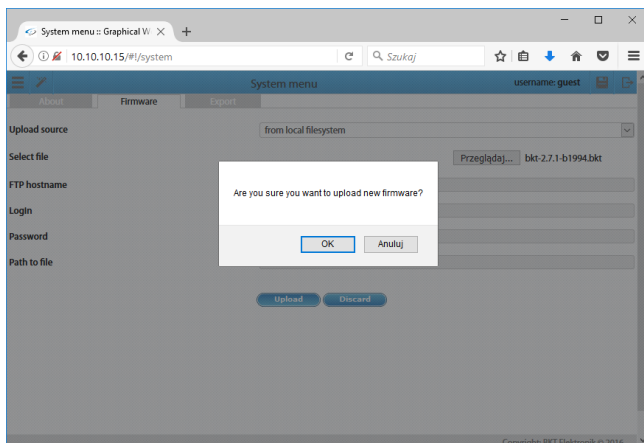

Click the *Upload* button and confirm to upload new firmware.

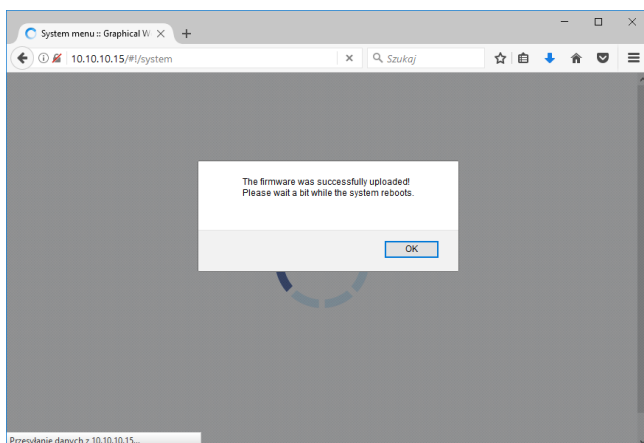

Wait until information on the completed update is displayed and the device is restarted. Refresh the browser using the CTRL+F5 keys.

7.16.4 Export data to a file

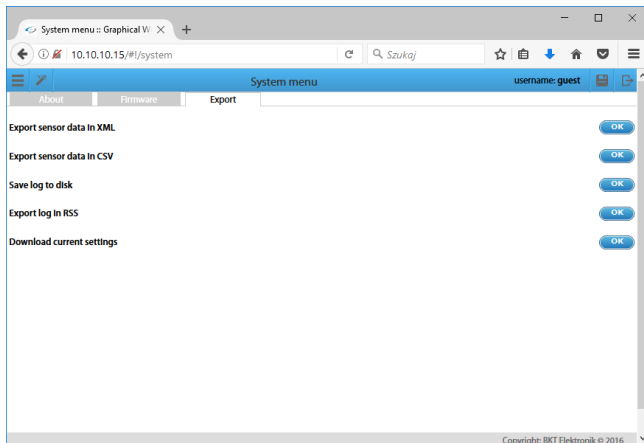

Select *Menu_Systemu*→*Export* from the vertical menu.

Export sensor data in XML – save the sensor data to an XML file. The file contains max 400 readings from each sensor:

- 100 readings (every second) from the last 100 seconds
- 100 readings (every minute) from the last 100 minutes
- 100 readings (every hours) from the last 100 hours
- 100 readings (every day) from the last 100 days

Export sensor data in CSV – save the sensor data in a CSV file.

Save log to disk – save system events to a TXT file.

Export log in RSS – system events in the RSS format.

Download current settings – save the current device settings to the settings.bkt file.

7.16.5 Restoring settings from a file

The method of saving data to a file is described in 7.16.4 Export data to a file.

NOTE: The current setting will be overwritten by the settings included in the file.

To restore the settings:

1. Copy the settings.bkt file to a USB flash drive (pendrive).
2. Connect the flash drive (pendrive) to the mini-B USB socket of the controller using an attached cable and wait for a while.
3. Start of the setting restoration process is indicated by the ERROR light, whereas successful completion of the same is indicated by the ACT light flashing.
4. Restart the device.
5. The device settings have been restored from the file.

8 DOCUMENT REVISIONS

Version	Changes	Date
1	Initial version	May 2017
2	Updated with hardware modifications	January 2018