

PROPER USE GUIDELINES

Cumulative Trauma Disorders can result from the prolonged use of manually powered hand tools. Hand tools are intended for occasional use and low volume applications. A wide selection of powered application equipment for extended-use, production operations is available.



Figure 1

1. INTRODUCTION

This instruction sheet covers the proper use and maintenance of Tool Kits 1725150-[] for AMP NETCONNECT* SL Series 110 and AMP-TWIST* 6S, AMP-TWIST 6AS SL, and AMP-TWIST 7AS SL Jack Connectors. See Figure 1.

This tool kit is designed to terminate:

Product Description	Cable Type (AWG)
SL Series 110 Jack Connectors	22-24 Solid 24 Stranded
AMP-TWIST* 6S SL Jack Connectors	22-24 Solid 24-26 Stranded
AMP-TWIST 6AS SL Jack Connectors	22-24 Solid 24 Stranded
AMP-TWIST 7AS SL Jack Connectors	22-24 Solid

NOTE



Dimensions in this instruction sheet are in millimeters [with inches in brackets]. Figures and illustrations are for reference only, and are not drawn to scale.

To obtain information on NETCONNECT* products, call PRODUCT INFORMATION at the number at the bottom of this page, or visit www.comscope.com.

Reasons for revision are given in Section 8, REVISION SUMMARY.

2. DESCRIPTION

Tool kit part number 1725150-1 for SL 110 Series Jack Connectors consists of:

- S Tool Assembly 1901551-1
- S Lacing Fixture 1673956-1
- S Hand Tool Pouch 1725504-1

Tool kit part number 1725150-3 for AMP-TWIST 6S, 6AS, and 7AS SL Jack Connectors consists of:

- S Tool Assembly 1901551-1
- S No lacing fixture
- S Hand Tool Pouch 1725504-1

Read these instructions carefully before using this tool.

2.1. Description of SL Series Jack Tool Assembly 1901551-1

The tool assembly consists of a spring-loaded ram driven by a handle through a link.

The ram, which also acts as a handle lock (to keep the handle closed during transportation and storage), can move independently of the link for purposes of cable stripping and to unlock the handle.

A spring provides the force necessary for the cable stripping operation.

A blade to place a score mark on foil covered cable pair.

All the parts are located inside two housing shells.

The housing features a scale for determining strip length and an access hole for cable stripping.

The tool assembly also provides a means to store and retain Lacing Fixture 1673956-1 when the fixture is not in use.

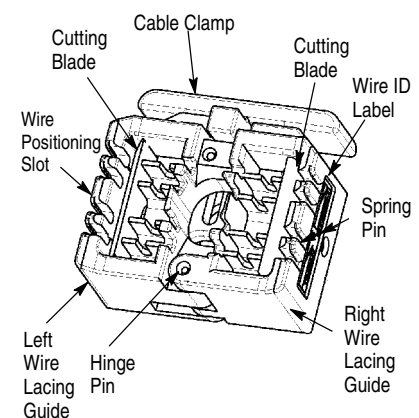

(View of 1673956-1)

Figure 2

2.2. Description of Lacing Fixture Assembly

NOTE
 The lacing fixture is only used on SL Series 110 Jack Connectors

Each Lacing Fixture Assembly 1673956-1 consists of two wire lacing guides that pivot around a pin. Refer to Figure 2.

Each wire lacing guide has a cut-off blade, to cut off the excess wire during termination.

In addition, Lacing Fixture 1673956-1 contains a ball detent to assist in keeping the lacing fixture closed while lacing the conductors. The fixture also contains a movable cable clamp, which is used to prevent cable movement during the wire lacing process.

3. TERMINATION PROCEDURE FOR SL SERIES 110 JACK CONNECTORS

3.1. Terminating Unshielded Cable

1. Prepare the tool by pulling the ram toward the lacing fixture, unlocking the handle. Lift the handle "up" and remove the lacing fixture. Pull the ram forward and return the handle to the "locked" position.

2. Place the strain relief on the cable with the circular boss facing away from the end of the cable to be terminated. Refer to Figure 13.

3. Place the cable next to the scale on the side of the tool. Stop the end of the cable at the mark below the desired strip length (indicated in mm). Refer to Figure 3.

NOTE
 A 35mm [1.378 in. strip length is a good starting point.

4. Grasp the cable at the end of the tool. That is considered the reference point for the scale.

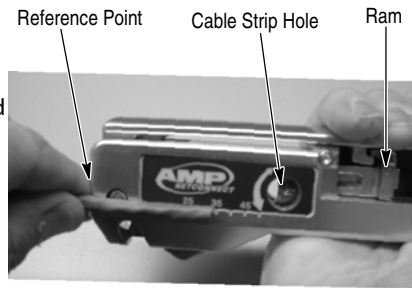

Figure 3

5. Pull the ram completely forward and insert the cable through the strip hole until the reference point meets the outside surface of the tool. See Figure 4.



Figure 4

6. Release the ram. The spring will provide the force for the cable stripping operation.

7. Rotate the tool around the cable. Approximately one and 1/4 turns are normally sufficient to cut through the cable jacket.

NOTE
 Harder cable jackets may require additional turns.

An arrow next to the cable strip hole indicates the direction of rotation for different depth cuts.

Rotating the tool in the direction of the smaller arrow will provide a minimal cut; rotating the tool in the direction of the larger arrow will provide a deeper cut.

NOTE
 It is recommended that the minimum depth be cut first. If a deeper cut is required, rotate the tool in the direction on the larger arrow.

8. Pull the ram forward and remove the cable.

9. Remove the cut cable jacket, rip cord, binder, and cross web filler if they exist, leaving only the twisted pairs of wire. See Figure 5.



Figure 5

NOTE
 If the cable is partially scored, bending the cable at the point of the cut and pulling it away from the cable will remove the cable jacket.

10. Open the lacing fixture and insert the cable until the cable jacket is aligned with the shelf. See Figure 6.

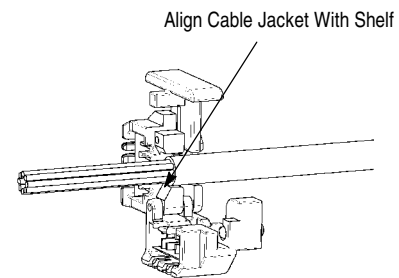



Figure 6

11. Rotate the cable so that the pairs of wires are oriented approximately with the wiring label on the outside of the lacing fixture.

NOTE
 The blue and brown wires can be used as guides. When using color code standards T568A or T568B, these conductors are in the same location.

12. Close the lacing fixture around the cable. Lacing fixture 1673956-1 contains a ball detent to keep the fixture closed. This fixture should be held by the cable clamp and by the bottom to keep the the cable from moving during wire lacing. Refer to Figure 7.

13. Following the wire identification label, use the inside towers between the the wire positioning slots to begin to separate the wire pairs. Untwist just enough of the wire to lay straight across the lacing

fixture to the outside wire position slot. See Figure 7.

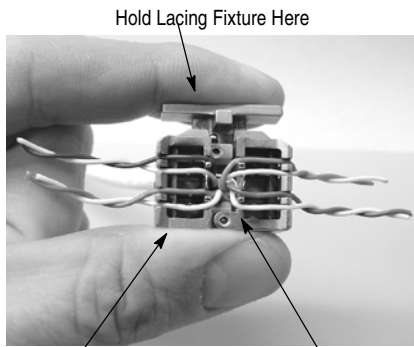

Figure 7

14. Orient the jack connector so that the color coding on the jack connector mates with proper conductor of lacing fixture. Insert a jack connector into the lacing fixture until it is engaged by approximately 4mm [.160 in.]. See Figure 8.

NOTE The blue and brown wires can be used as guides. When using color code standards T568A or T568B, these conductors are in the same location.

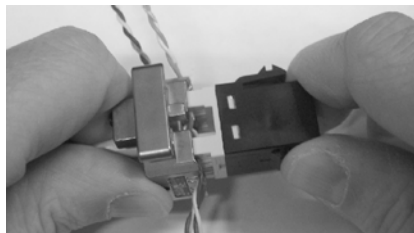

Figure 8

15. Insert the lacing fixture (with the jack connector) into the tool. See Figure 9.

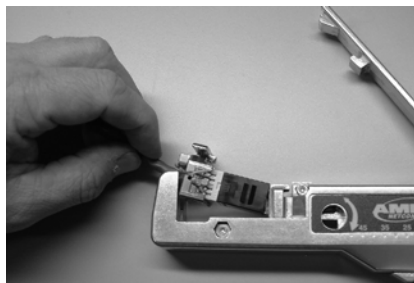

Figure 9

CAUTION

If the jack connector is equipped with a dust cover, the cover must be opened prior to insertion into the tool. See Figure 10. If the jack connector is terminated with the cover closed, the connector will be damaged and must be discarded.

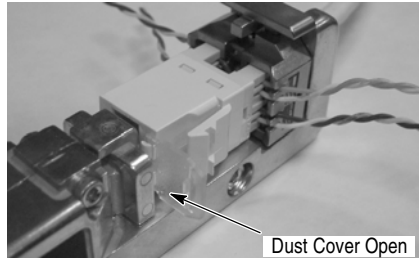

Figure 10

16. When using the lacing fixture and plastic SL Jack Connectors, squeeze the tool handle until the hook on the bottom of the handle meets the top of the ram. See Figure 11. Then release the handle and remove the lacing fixture and connector.



Figure 11

17. If necessary, remove the cut wires from the lacing fixture and discard them.

18. Remove the jack connector from the lacing fixture as follows:

- a. Hold the lacing fixture firmly with one hand and the jack connector with the other hand.
- b. Slightly move (wiggle) the connector back and forth while pulling in opposite directions. See Figure 12.

NOTE

Be sure not to hold the lacing fixture by the cable clamp. Holding the cable clamp will provide additional force on the cable and make it difficult to release the jack connector.

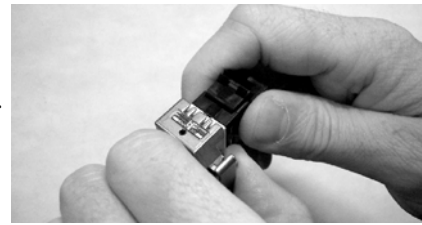

Figure 12

19. Open the lacing fixture and remove it from the cable and properly terminated jack connector. Inspect the connector to ensure the wires are bottomed in the housing slots and the wires were cut properly.

20. For *unshielded* jack connectors, position the strain relief over the connector and snap into place. Refer to Figure 13.

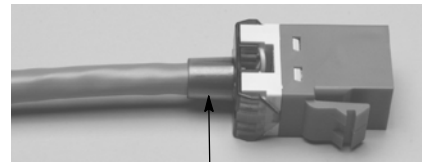

Figure 13

21. If no further terminations are required, place the lacing fixture in the tool and lock the handle in the closed position. The lacing fixture will be retained by the tool.

CAUTION

Damaged product should not be used. If a damaged product is evident, it should be cut from the cable and replaced with a new one.

3.2. Terminating Shielded Cable

1. Strip back the cable jacket approximately 76.2mm [3.00 in.].

NOTE

It is recommended that the minimum depth be cut first. If a deeper cut is required, rotate the tool in the direction of the larger arrow (Figure 14).

If the cable is partially scored, bending the cable at the point of the cut and pulling it away from the cable will remove the cable jacket.

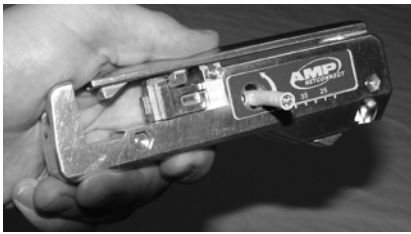

Figure 14

2. Remove ripcord if present. Do not cut the foil. See Figure 15.

3. Fold the metal foil and drain wire back over cable jacket. See Figure 16.



Figure 15

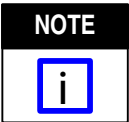

NOTE Do NOT cut the drain wire. Fold back the foil toward cable jacket as shown in Figure 16.

4. Remove the clear wrapping from the twisted-pair wires. Refer to Figure 17.



Figure 16



Figure 17

5. Cut the center spline filler 12.7 mm [.500 in.] minimum from the end of the cable jacket. See Figure 18.

6. Open the lacing fixture and insert the cable until the top of the center spline filler is aligned with the shelf of the fixture as shown in Figure 19.

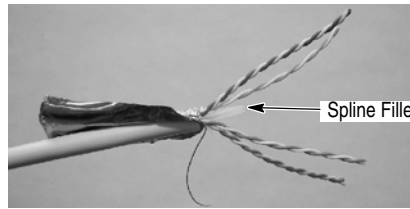

Figure 18



Figure 19

7. Continue as described in the instructions for terminating unshielded cable (Paragraph 3.1, Steps 10 through 18).

8. After removing the connector from the cable and inspecting it, place the foil so that the conductive side is facing outward and the foil is over the twisted pair conductors for 360°. Pull the foil toward the jack, form foil around twisted conductors then fold back toward the cable jacket. See Figure 20 and Figure 21. Inspect the jack to ensure the wires are bottomed in the housing slots and the wires were cut properly.



Figure 20

9. Wrap the drain wire 360° around the foil.

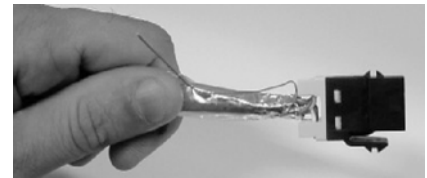

Figure 21

10. Insert the SL Jack into the shield. See Figure 22.

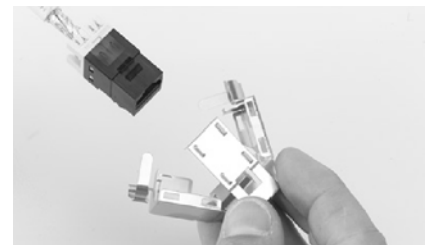

Figure 22

11. Pinch the top and bottom of the shield while simultaneously pinching the sides of the shield. See Figure 23.

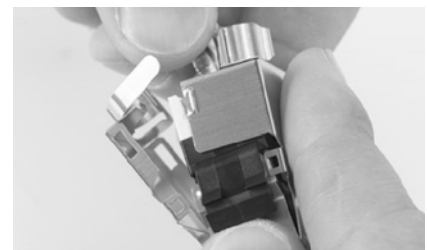

Figure 23

12. The top and bottom of the shield should be on the inside of the tabs on the left and right sides of the shield. Lead shield strain relief belts into slots and continue closing until the holes in the tabs snap over the latches. See Figure 24.

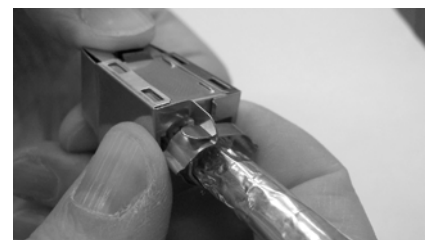

Figure 24

13. Firmly squeeze shield belts tightly around the foil. Fold the belt ends up and over the shield as shown in Figure 25.

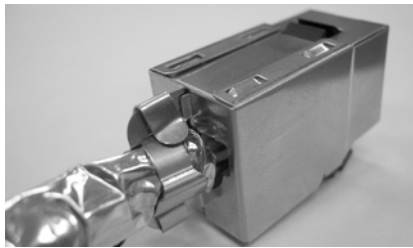

Figure 25

14. Using long-nosed pliers, tighten the shield by squeezing the crimp ribs provided. See Figure 26 and Figure 28.



Figure 26

15. Use long-nosed pliers to crimp the shield belts over the shield strain relief. Refer to Figure 27 and Figure 28.

16. Be sure that the shield strain relief is making 360° of contact with the foil and drain wire.



Figure 27

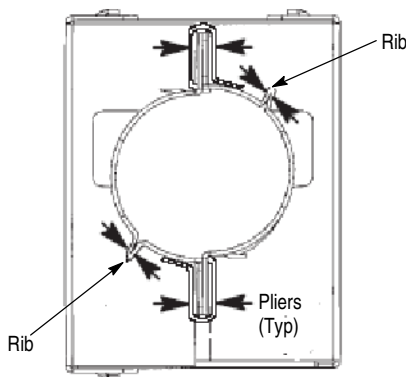

Figure 28

The completed assembly should appear as shown in Figure 29.

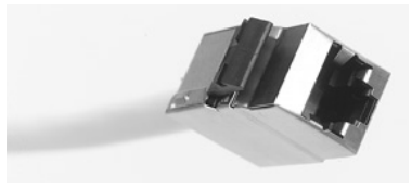

Figure 29

4. TERMINATION PROCEDURES FOR 6S SL JACK CONNECTORS, 6_AS SL JACK CONNECTORS, and 7_AS SL JACK CONNECTORS

Refer to the following instructions for termination instructions:

Instructions	Product Description
411-93007	AMP-TWIST 6S SL Jack, Straight Exit Connectors
411-93014	AMP-TWIST 6S SL Jack, Side Exit Connectors
411-93016	AMP-TWIST 6 _A S SL Jack Connectors
411-93013	AMP-TWIST 7 _A S SL Jack Connectors

CAUTION WHEN TERMINATING THE ABOVE METAL CONNECTORS, do not squeeze the handle of the tool beyond the point where the rear housing latches into the front housing of the jack. Damage to the tool may result.

5. MAINTENANCE

Periodically clean the tool. The tool is lubricated at the factory and should not require additional lubrication except during blade replacement.

6. PARTS REPLACEMENT

6.1. Jack Connector Tool Strip Blade Replacement

To replace the strip blade on Tool Assembly 1901551-1, refer to Figure 30 and proceed as follows:

1. First open the handle. This relieves the spring pressure. Then remove the lacing fixture.
2. Remove the three screws holding the tool housings together.
3. Carefully remove one of the housings.



Exercise caution so that the spring does not fly out of the housings when the housings are removed. **DO NOT LOSE THE SPRING.**

4. Remove the ram.
5. Remove the blade from the ram by removing the cap screw securing the blade.
6. Install a new strip blade. Be sure the back of the blade is up against the wall of the ram.
7. Tighten the cap screw that holds the strip blade.
8. Lubricate the bottom of the ram surfaces with CHEVRON® Ultra-Duty EP2 grease or equivalent.
9. Install the spring and place the previously removed housing over top of the assembly.
10. Using a small, thin object, compress the spring until the housings can be pressed together.
11. Very lightly, tighten the three cap screws.
12. Place the tool on a flat surface to align the bottoms of the housing.
13. Fully tighten the three cap screws.
14. Align the inside of the legs of the housing that push against the lacing fixture.

{ CHEVRON Products Company
San Ramon, CA



Do not strip the top cap screw. hole.

CUSTOMER SERVICE (38-35)
TYCO ELECTRONICS
PO BOX 3608
HARRISBURG PA 17105-3608

15. Slide the ram back and forth.

16. Remove any extra grease that may have entered the cable strip

Other replacement parts can be ordered through a Tyco Electronics Representative, or call 1.800.526.5142, or send a facsimile of your purchase order to 1.717.986.7605, or write to:

7. REVISION SUMMARY

S Replaced stripping blade 231674-2 with a two holed version.

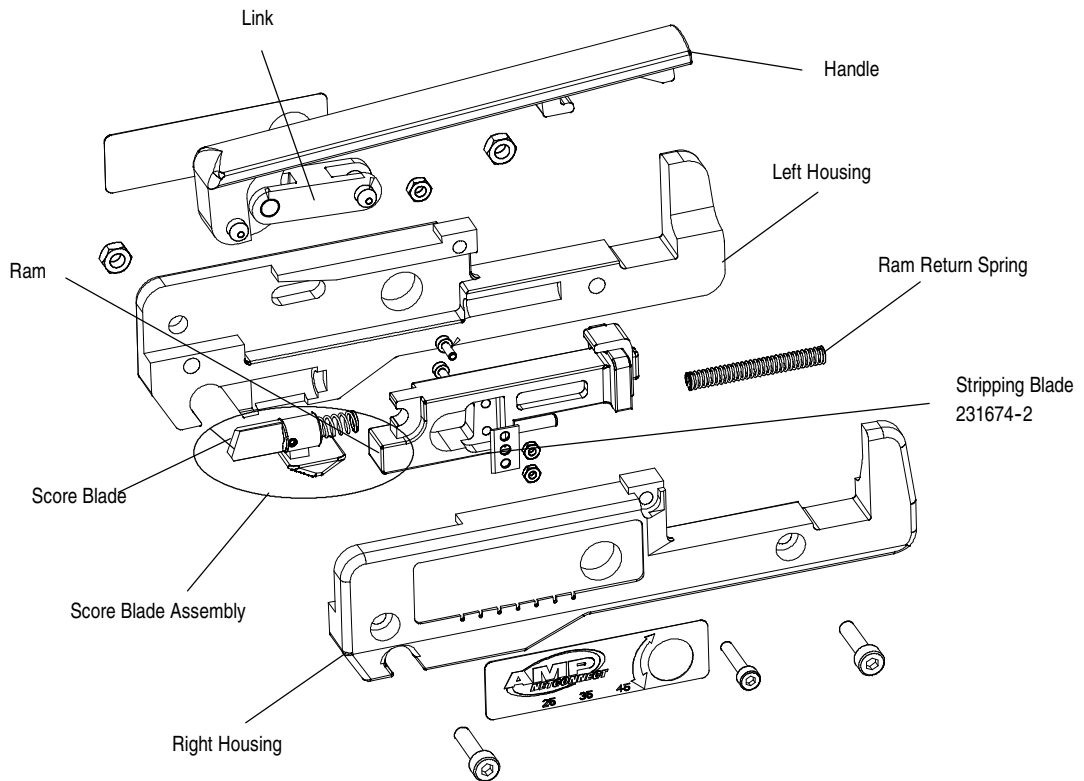

Figure 30